

REQ. PER UNIT	MODEL	USED ON ASS'Y. NO.	DATE
	WIRE-1		8/11/65
			CH506

FINAL ASSY
RF MODULE
AX599

MODULE
SUB-ASSY
A4326

PC BOARD
ASSY
A4299

TRANS, RF,
TUNED
TT 272

TRANS, RF,
TUNED
TT 273

TRANS, RF,
TUNED
TT 271

REQ. ITEM	PART NO.	DESCRIPTION	SYMBOL
		THE TECHNICAL MATERIEL CORP. MAMARONECK. NEW YORK	
		CHART, UNIT BREAKDOWN (RF MODULE)	
		DRAWN / CHECKED	
		TYPE & TEMPER / HEAT TREAT. SPEC.	
		MATERIAL	
		FINISH & SPEC. NO.	CH506
		DATE	8/11/65
		CH. NO.	-
		DRAFTS CHECKER	A
		ENG. APP.	
		SCALE	
		DESCRIPTION	ORIGINAL RELEASE
		UNLESS OTHERWISE SPECIFIED DIMENSIONS ARE IN INCHES AND INCLUDE CHEMICALLY APPLIED OR PLATED FINISHES	
		DECIMALS	
		FRACTIONS	
		TOLERANCES	
		ANGLES	
		FINISHES	
		FINAL APPROVAL	MMK 8/12/65
		ELEC. DES. APP.	
		MECH. DES. APP.	

USED ON
CH 511 A

REQ. PER UNIT
1

MODEL
AK101

DATE

AUX KEYS
AK101

CHRS ASSY,
KEYER
A4287

PC BD
ASSY
A4296

REQ. ITEM	PART NO.	DESCRIPTION	SYMBOL
		THE TECHNICAL MATERIEL CORP. MAMARONECK. NEW YORK	
		CHART, UNIT BKDN	
		H. SCHMIDT 6-10-65	
		L. GABERL 9-20-65	
		DRAWN	CHECKED
		HEAT TREAT. SPEC.	FINAL APPROVAL
		FINISH & SPEC. NO.	ELEC. DES. APP. MECH. DES. APP.
			CH 511 A

SCALE:
MAXIMUM ALLOWABLE TOLERANCES HAVE BEEN DETERMINED AND ANY DEVIATIONS WILL BE CAUSE FOR REJECTION. REMOVE ALL BURRS AND SHARP EDGES

ISSUE ITEM
A - ELK. A4287 DELETED
ORIGINAL RELEASE FOR PRODUCTION
CHANGED FROM

DATE
14 May 66

CH. NO.
15064

DRAFTS
AVK
AVK

CHECKER
JCB

ENG. APP.

TOLERANCES
DEC. DIM. ±
FRAC. DIM. ±
ANGULAR DIM. ±

CH513

USED ON
 REQ. PER UNIT: 1
 MODEL: RCWB-1
 ASSY. NO.:
 DATE: 10-5-65

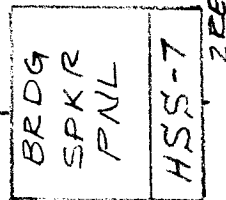
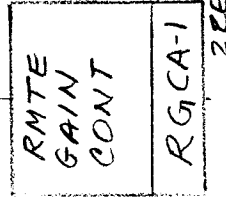
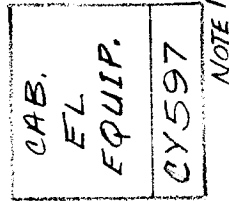
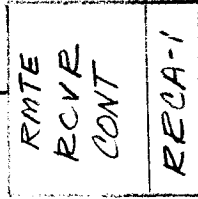
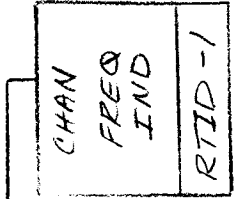
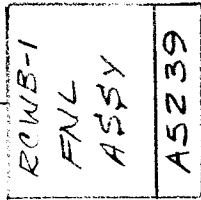
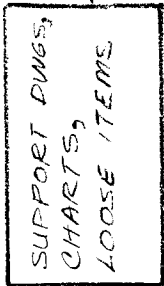
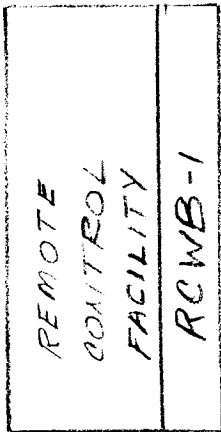

NOTE: ALL ITEMS REFERENCED TO THIS NOTE ARE CUSTOMER SUPPLIED.

REQ. ITEM	PART NO.	DESCRIPTION	SYMBOL
		THE TECHNICAL MATERIEL CORP. MAMARONECK, NEW YORK	
		CHARTS UNIT BREAKDOWN	
		MATERIAL	RCWB-1
		TYPE & TEMPER	19/65 10-13-65
		HEAT TREAT. SPEC.	10/14/65
		FINISH & SPEC. NO.	04513
		ELEC. DES. APP.	
		MECH. DES. APP.	

USED ON
 MODEL
 ASSY. NO.
 DATE

REQ. PER UNIT
 1
 1

CH514
 CH514
 CH514

DDRR-5M
 AK101
 10-5-65

DDR-5BR
 AK101
 10-5-65

SHUNT RESISTOR CHART - 60 MA LOOP, NEUTRAL

NO. OF UNITS	RESISTOR VALUE	RESISTOR PART NO.
1	200 OHM	RC42GF201J
2-10	220 OHM	RC42GF221J
11-20	240 OHM	RC42GF241J
21-30	270 OHM	RC42GF271J
31-40	300 OHM	RC42GF301J
41-50	330 OHM	RC42GF331J
51-60	360 OHM	RC42GF361J
61-70	430 OHM	RC42GF431J
71-80	510 OHM	RC42GF511J
81-90	620 OHM	RC42GF621J
91-100	750 OHM	RC42GF751J

NOTE: ALL RESISTANCE VALUES ARE OHMS, 2 WATT

REQ. ITEM	PART NO.	DESCRIPTION	SYMBOL
		THE TECHNICAL MATERIEL CORP. MAMARONECK. NEW YORK	
		CHART, SHUNT RESISTOR	
		ENG COORD 10-5-65	
		L. GABEL 10-5-65	
		DRAWN	
		CHECKED	
		FINAL APPROV	
		FINISH & SPEC. NO.	CH514
		ELEC. DES. APP.	
		MECH. DES. APP.	

REQ. PER UNIT
1 EA

MODEL
SBS-7

USED ON
ASSY. NO.
AX303-2, 304-2

DATE
CH515

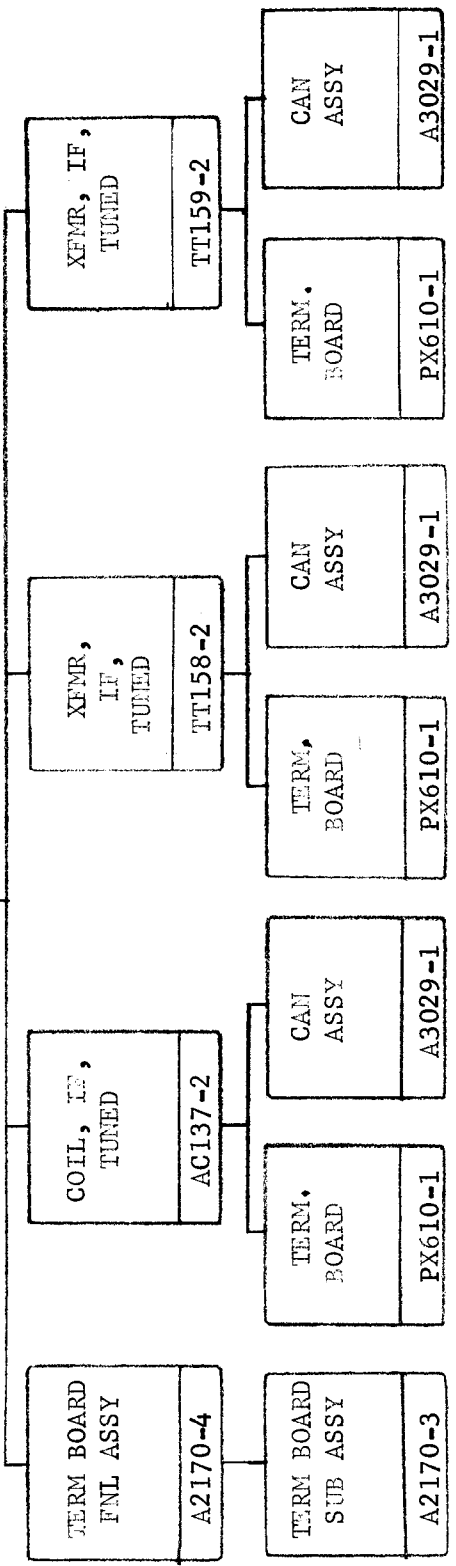
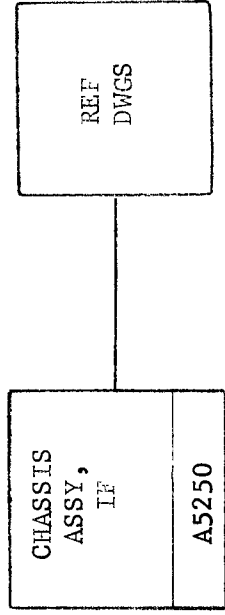

REQ. ITEM	PART NO.	DESCRIPTION	SYMBOL
		STOCK SIZE	
		MATERIAL	
		TYPE & TEMPER	
		HEAT TREAT. SPEC.	
		DRAWN	
		CHECKED	
		ENG. COORD	
		10/22/65	
		SCALE	
		DATE	
		CH. NO.	
		DRAFTS	
		CHECKER	
		ENG. APP.	
		CODE	
		UNLESS OTHERWISE SPECIFIED DIMENSIONS ARE IN INCHES AND INCLUDE CHEMICALLY APPLIED OR PLATED FINISHES	
		FRACTIONS ± 1/64 ANGLES ± 0° 30'	
		DECIMALS .X ± .05 .XX ± .01 .XXX ± .005	
		TOLERANCES	
		FINISH & SPEC. NO.	
		ELEC. DES. APP.	
		MECH. DES. APP.	
		FINAL APPROVAL	
		CHART, UNIT BREAKDOWN	
		THE TECHNICAL MATERIEL CORP. MAMARONECK, NEW YORK	
		CH515	

REQ. PER UNIT	MODEL	ASSY. NO.	DATE
1 EA	SBS-7	AX305-2,306-2	

CH 516

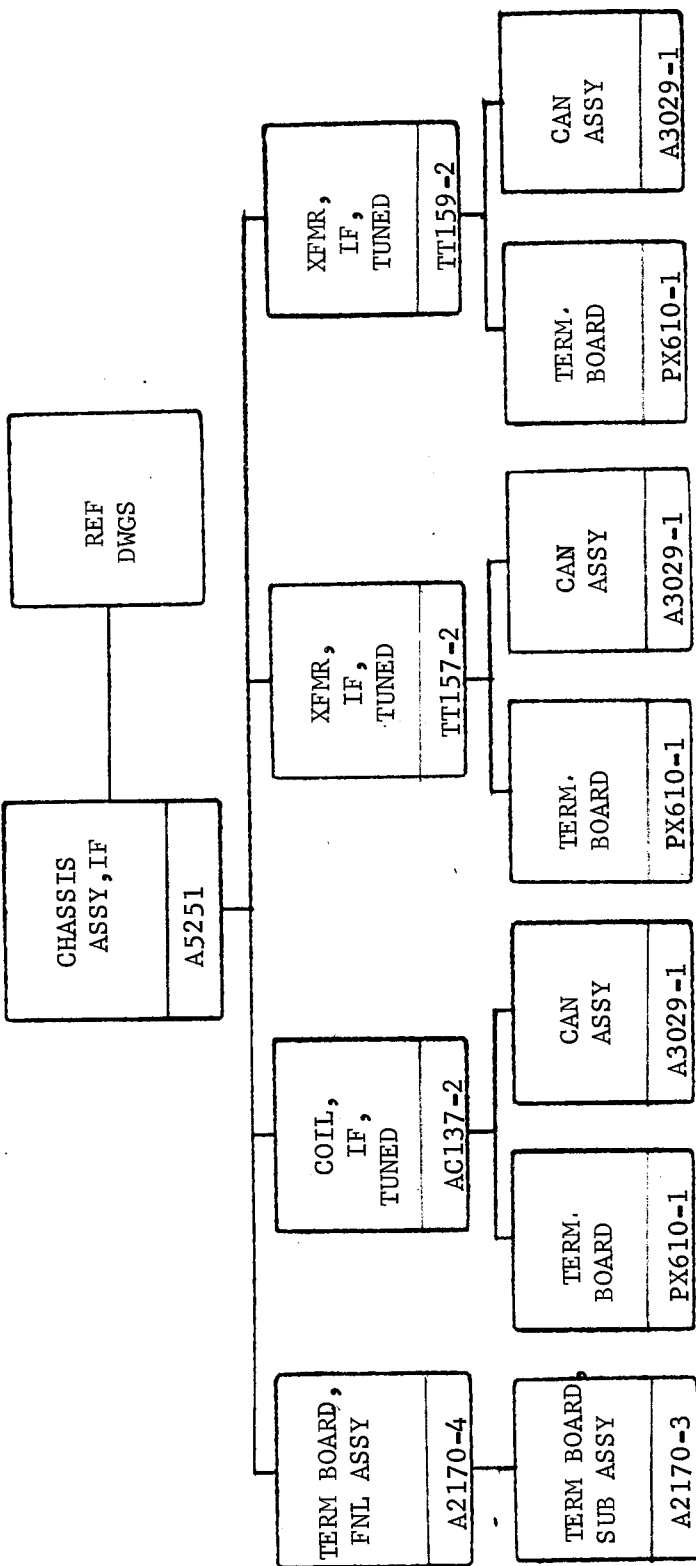

SYM	DESCRIPTION	PART NO.	REQ. ITEM	REVISION	SYMBOL
	THE TECHNICAL MATERIEL CORP. MAMARONECK, NEW YORK				
	CHART, UNIT BREAKDOWN				
	STOCK SIZE				
	MATERIAL				
	ENG. COORD				
	DRAWN				
	CHECKED				
	TYPE & TEMPER				
	HEAT TREAT. SPEC.				
	FINISH & SPEC. NO.				
	ELEC. DES. APP.				
	MECH. DES. APP.				
	FINAL APPROVAL				
					CH 516

ORIGINAL RELEASE

UNLESS OTHERWISE SPECIFIED
DIMENSIONS ARE IN INCHES AND INCLUDE
CHEMICALLY APPLIED OR PLATED FINISHES

DECIMALS
.X ± .05
.XX ± .01
.XXX ± .005

FRACTIONS
± 1/64
ANGLES
± 0° 30'

TOLERANCES

CH 517

USED ON
 REQ. PER UNIT: 1
 MODEL: RTMU
 ASSY. NO.: A4254
 DATE: 10/18/65

RTRS CHAR RECOG	JUMPER CONNECTIONS (TERM. to TERM.)										TELETYPE CHARACTER	BINARY CODE
	A	B	C	D	E	F	G	H				
A					3	4	7	5			Y	10101
B					3	4	2	8			F	10110
C					1	6	2	8			J	11010
D					1	6	7	5			W	11001
E					3	6	2	5			B	10011
F					1	4	7	8			U	11100
G					3	4	7	8			S	10100
H					3	6	2	8			D	10010
I					3	6	7	5			Z	10001
J					1	6	7	8			A	11000
1	1	6	2	8							R	01010
2	1	6	7	5							L	01001
3	3	4	7	5							H	00101
4	3	4	2	8							N	00110
5	1	4	7	8							I	01100
6	3	6	2	5							O	00011
7	1	6	2	5							G	01011
8	1	4	7	5							P	01101
9	1	4	2	8							C	01110
10	3	4	2	5							M	00111

REF: PC BD A4254/PC218

REQ. ITEM	PART NO.	DEMARCO	DESCRIPTION	SYMBOL
			THE TECHNICAL MATERIEL CORP. MAMARONECK. NEW YORK	
			A4245 JUMPERS	
			STOCK SIZE	
			MATERIAL	
			ENG COORD 10/18/65	
			DRAWN	
			CHECKED	
			FINAL APPROVAL	
			TYPE & TEMPER	
			HEAT TREAT. SPEC.	
			FINISH & SPEC. NO.	
			ELEC. DES. APP.	
			MECH. DES. APP.	

Ø ORIG. REL. FOR PROD. 1-29-69
 DATE: 1-29-69
 SCALE: R.G.
 UNLESS OTHERWISE SPECIFIED
 DIMENSIONS ARE IN INCHES AND INCLUDE
 CHEMICALLY APPLIED OR PLATED FINISHES
 TOLERANCES
 DECIMALS
 .X ± .05
 .XX ± .01
 .XXX ± .005
 FRACTIONS
 ± 1/64
 ANGLES
 ± 0° 30'

REQ. PER UNIT	1
MODEL	RTPH-1
ASSY. NO.	#
DATE	11-18-65

USED ON	CH 523
---------	--------

ELECTRONIC PROGRAMER
RTPH-1

REF DWGS
LOOSE ITEMS

RTPH-1
FNL ASSY
A5338

RTPH-1
SUB ASSY
AX617
NPL

REQ. ITEM	PART NO.	DESCRIPTION	SYMBOL
		EATON	
		THE TECHNICAL MATERIEL CORP. MAMARONECK, NEW YORK	
		CHART, UNIT BREAKDOWN	
		JMUNFORD 11-18-65	
		DRAWN	
		CHECKED	
		FINAL APPROVAL	
		CH 523	

CH524

CH524

REV: Q

COMPILED: *Zg* 5/5/66

CHECKED: *Zg*

APPD: *Zg* ~~MMK~~

SHEET

1

OF

2

TITLE:

CHART, UNIT BREAKDOWN, AX618

		<u>QTY</u>
AX618	RTIH SUBASSY	1
. A4376 (NPL)	MEM CKT,MC	1
. A4377 (NPL)	MEM GT CKT,KC	2
. A4379 (NPL)	SHIFT REG/1-2	1
. A4381 (NPL)	SHIFT REG/3456	1
. A4390 (NPL)	PWR SUP.ASSY	1
. A4395 (NPL)	GATING CKT,MC	1
. A4397 (NPL)	TIMING CKT,IN.	1
. A4398 (NPL)	GATING CKT,IN.	1
. A4399 (NPL)	TIMING/SET-RES	1
. A5351	CHAS/FRAME ASSY	1
.. A5352	PL ASSY,REAR	1
... A5467	FAN ASSY	1
.... CA409-206-14.00	LEAD,ELEC	2
.... CA409-207-14.00	LEAD,ELEC	2
.... CA409-208-14.00	LEAD,ELEC	2
... AK102 (NPL)	AUX KEYER	1
.. A5353	PL ASSY,L SD	1
.. A5354	PL ASSY,R SD	1
.. A5355	PNL ASSY,FR	1
.. A5356	CHAS ASSY,MAIN	1
... A5358	RECT ASSY	1
... A5413	BIN ASSY,PC	1
... CA1222	WRG HARN,BRCHD	1
... CL292	COIL,RF,FXD	1

REQ. PER UNIT	1
MODEL	RTO-1
USED ON ASSY. NO.	
DATE	12/06/65

CH527

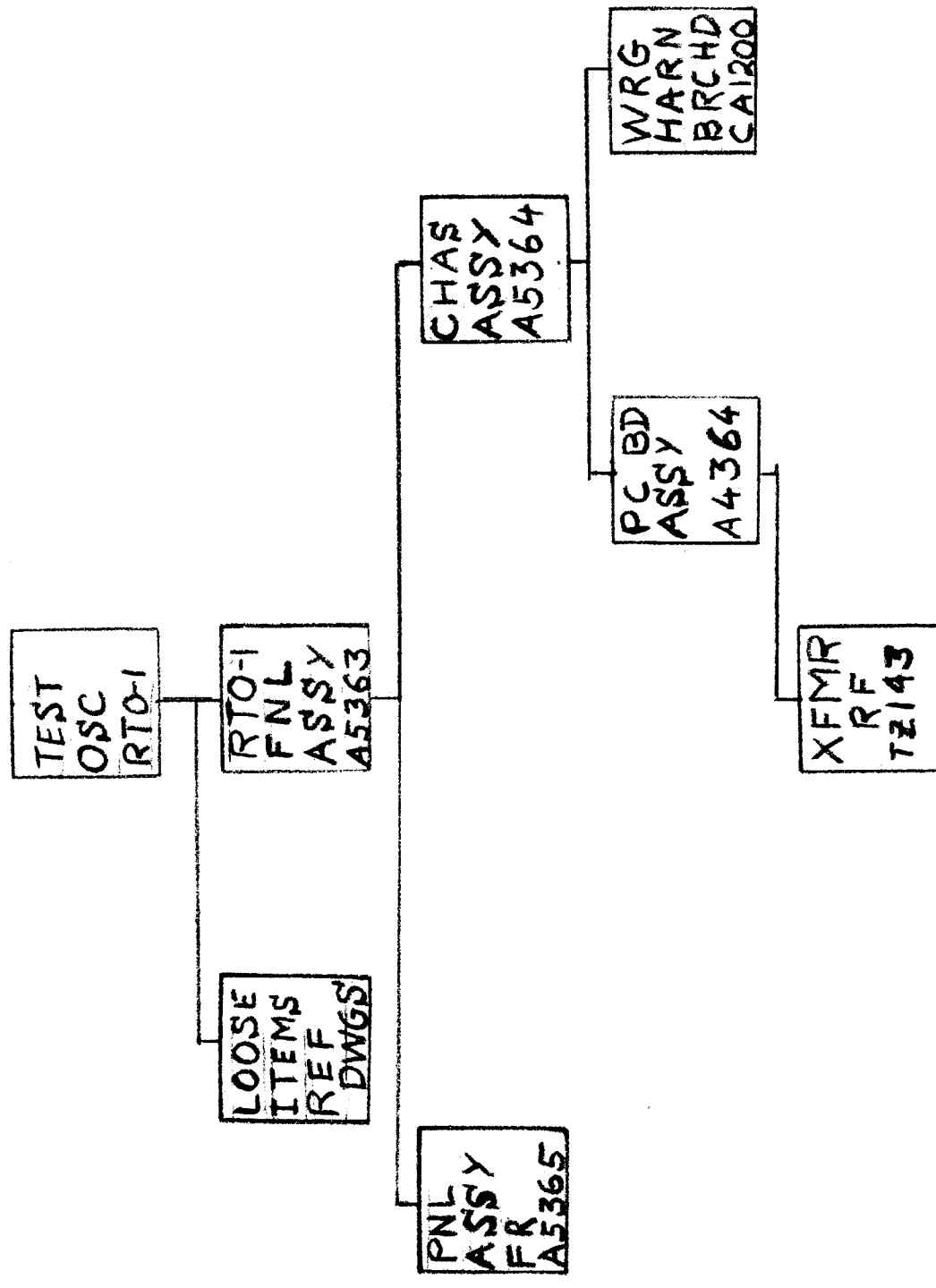

REQ. ITEM		PART NO.		DESCRIPTION	SYMBOL
				THE TECHNICAL MATERIEL CORP. MAMARONECK. NEW YORK	
		STOCK SIZE		CHART, UNIT BREAKDOWN	
		MATERIAL			
		TYPE & TEMPER	HEAT TREAT. SPEC.		
		FINISH & SPEC. NO.			
		ELEC. DES. APP.			
		MECH. DES. APP.			
				PC	
				12-6-65	
				12/6/65	
				FINAL APPROVAL	
				CH527	

USED ON CH 530
 REQ. PER UNIT
 MODEL KIT 270
 ASSY. NO.
 DATE 15 DEC 65

SWOVER
 MOD KIT
 KIT 270

WRG. HARN,
 BRCHD
 CA 1050

CBL ASSY,
 RF
 CA 480-3-12

CHAS ASSY
 SWOVER
 AX 619
 NPL

REQ. ITEM	PART NO.	DESCRIPTION	SYMBOL
		THE TECHNICAL MATERIEL CORP. MAMARONECK, NEW YORK	
		CHART, UNIT BREAKDOWN	
		H. SCHUCKER 15 DEC 65	
		L. GABEL 15 DEC 65	
		DRAWN CHECKED	
		MATERIAL	
		TYPE & TEMPER HEAT TREAT. SPEC.	
		FINISH & SPEC. NO.	
		ELEC. DES. APP. MECH. DES. APP.	
		FINAL APPROVAL	
		CH 530	

ISSUE ITEM
 CHANGED FROM
 ORIGINAL RELEASE FOR PRODUCTION
 DATE 12/15/65
 CH. NO.
 DRAFTS
 HAA
 CHECKER
 ENG. APP.
 SCALE:
 MAXIMUM ALLOWABLE TOLERANCES HAVE BEEN DETERMINED AND ANY DEVIATIONS WILL BE CAUSE FOR REJECTION.
 REMOVE ALL BURRS AND SHARP EDGES

DEC. DIM. ±
 FRAC. DIM. ±
 ANGULAR DIM. ±

REQ. PER UNIT	1	MODEL	KIT 270	USED ON	CH 531
ASSY. NO.	AX 619	DATE	15 DEC 65		

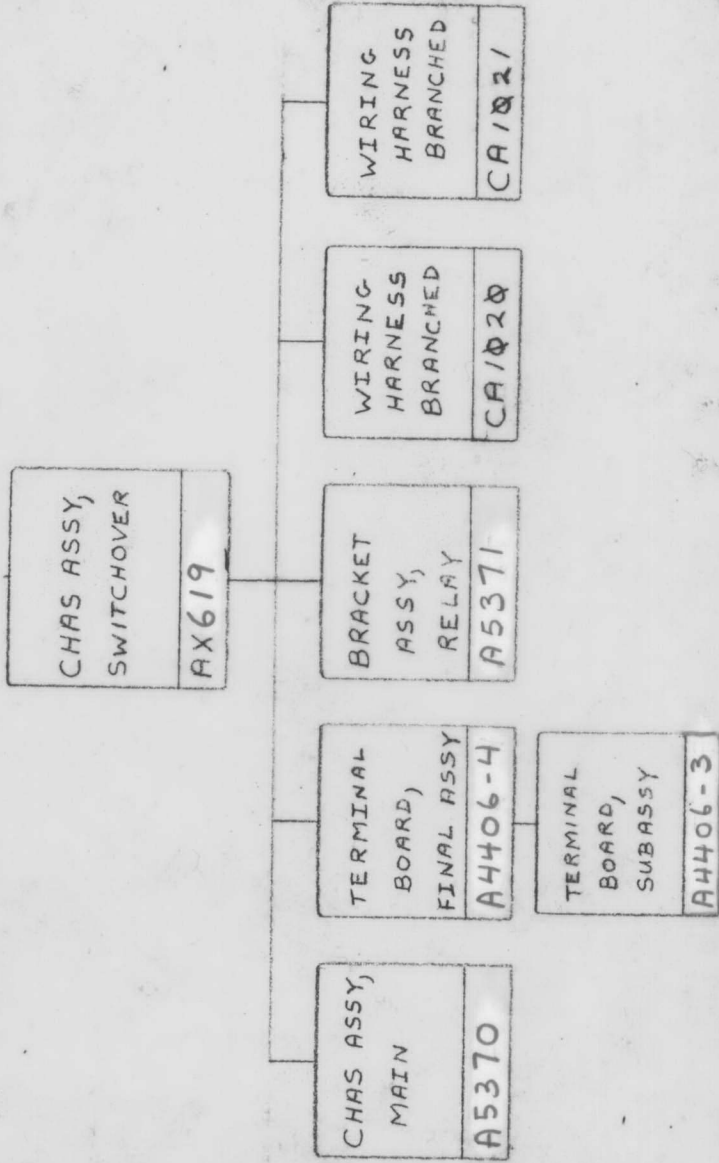

REQ. ITEM	PART NO.	DESCRIPTION	SYMBOL
		THE TECHNICAL MATERIEL CORP. MAMARONECK, NEW YORK	
		CHART, UNIT BREAKDOWN	
		H SCHAECKER 15 DEC 65	
		L. GABEL 15 DEC 65	
		DRAWN	
		CHECKED	
		FINAL APPROVAL	
		CH 531	

ORIGINAL RELEASE FOR PROD. 12/15/65
 DATE
 SCALE
 UNLESS OTHERWISE SPECIFIED
 DIMENSIONS ARE IN INCHES AND INCLUDE
 CHEMICALLY APPLIED OR PLATED FINISHES
 TOLERANCES
 DECIMALS
 X ± .05
 .XX ± .01
 .XXX ± .005
 FRACTIONS
 ± 1/64
 ANGLES
 ± 0° 30'

CH533

USED ON
 ASSY. NO. DATE
 17 DEC 65

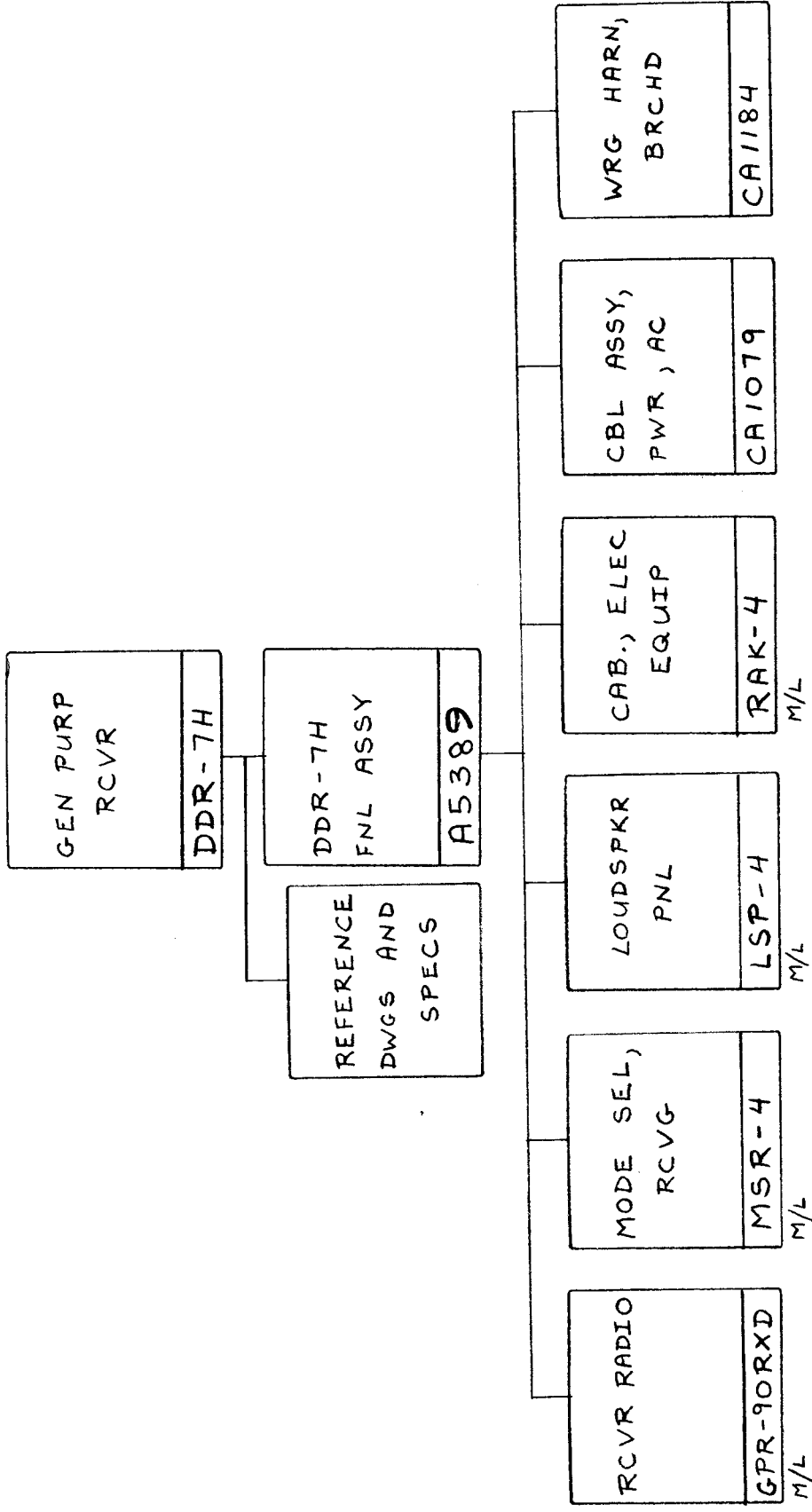

REQ. ITEM	PART NO.	DESCRIPTION	SYMBOL
		THE TECHNICAL MATERIEL CORP. MAMARONECK. NEW YORK	
		CHART, UNIT BKDN	
		H. SCHUCKER 17 DEC 65	
		DRAWN	
		CHECKED	
		FINAL APPROVAL	
		ELEC. DES. APP. MECH. DES. APP.	
		FINISH & SPEC. NO.	CH533
			Ø

REQ. PER UNIT:
 MODEL: VLRB-1
 ASSY. NO.: AX540
 USED ON:
 DATE: 12-20-65
 CH534

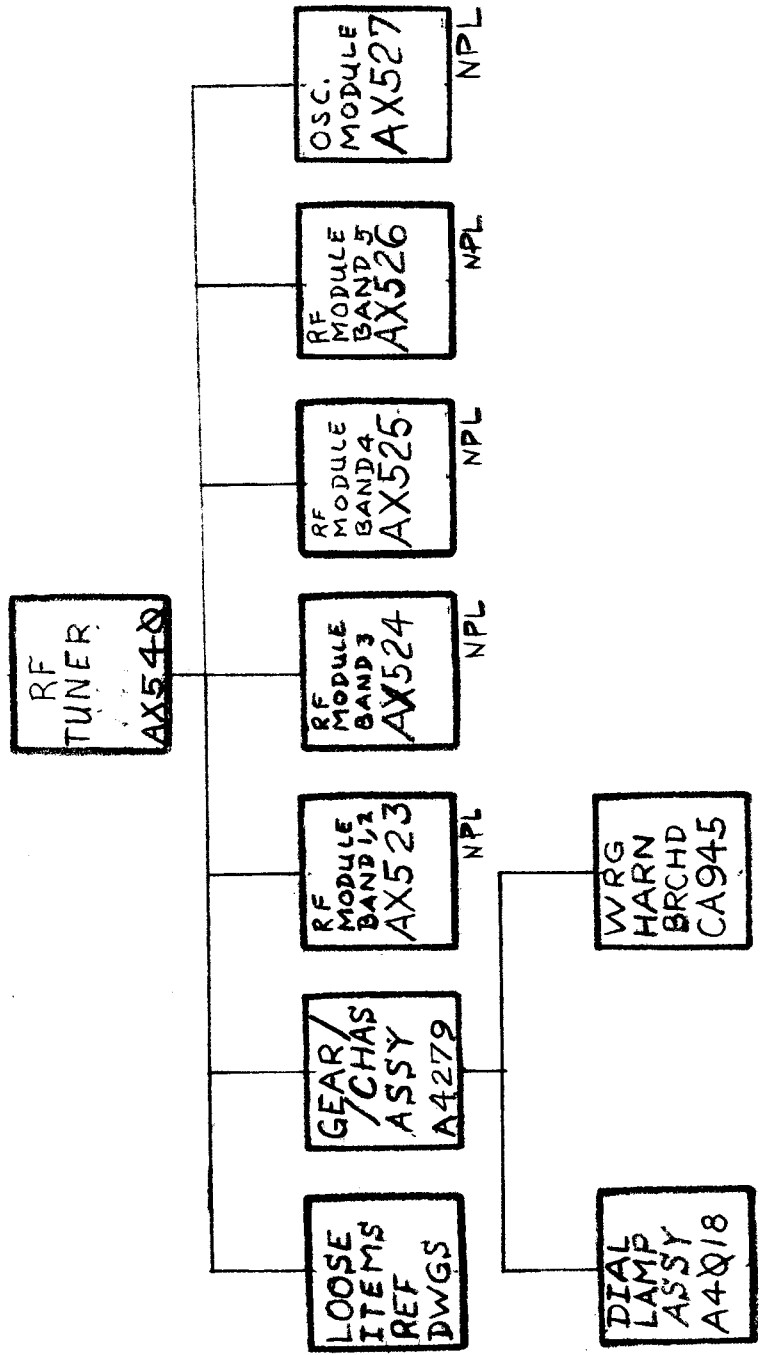

REQ. ITEM	PART NO.	DESCRIPTION	SYMBOL
		THE TECHNICAL MATERIEL CORP. MAMARONECK. NEW YORK	
		CHART, UNIT BREAKDOWN	
		STOCK SIZE	
		MATERIAL	
		TYPE & TEMPER	
		HEAT TREAT. SPEC.	
		CHECKED	
		DRAWN	
		FINAL APPROVAL	
		FINISH & SPEC. NO.	CH534
		ELEC. DES. APP.	
		MECH. DES. APP.	

DATE: 1/4/65
 SCALE:
 ORIGINAL RELEASE
 UNLESS OTHERWISE SPECIFIED
 DIMENSIONS ARE IN INCHES AND INCLUDE
 CHEMICALLY APPLIED OR PLATED FINISHES
 TOLERANCES:
 DECIMALS:
 X ± .05
 XX ± .01
 XXX ± .005
 FRACTIONS:
 ± 1/64
 ANGLES:
 ± 0° 30'

1	REMOTE TUNING INDICATOR	RTIH-1	A5393	RTIH-1
1	RTIH-1 FNL ASSY	RTIH-1 (NPL)	A4375	RTIH-1 (NPL)
5	MEM GT CKT	RTIH-1 (NPL)	AX618	AX618 (NPL)
1	RTIH-1 SUBASSY	LP106		
1	LOOSE IT. PKG			

QTY

CH536											
REV:	<input checked="" type="checkbox"/>										
COMPILED:	3/5/66		ZS		CHECKED:		ZS		APPD:		MM
SHEET 1 OF 2											
TITLE: CHART, UNIT BREAKDOWN - RTIH-1											

CH 536

DATE	REV.	SHEET	EMN #	DESCRIPTION	APP.
5/4/66	<input checked="" type="checkbox"/>	---	---	ORIGINAL RELEASE FOR PRODUCTION	
<p style="text-align: center;">REVISION SHEET</p> <p style="text-align: center;">THE TECHNICAL MATERIEL CORP. MAMARONECK NEW YORK</p> <p>CH536 LIST NO.</p>					

REQ. PER UNIT	USED ON	CH 537
	MODEL	
	RTIH-1	
	ASSY. NO.	
	-#	
	DATE	12-30-66

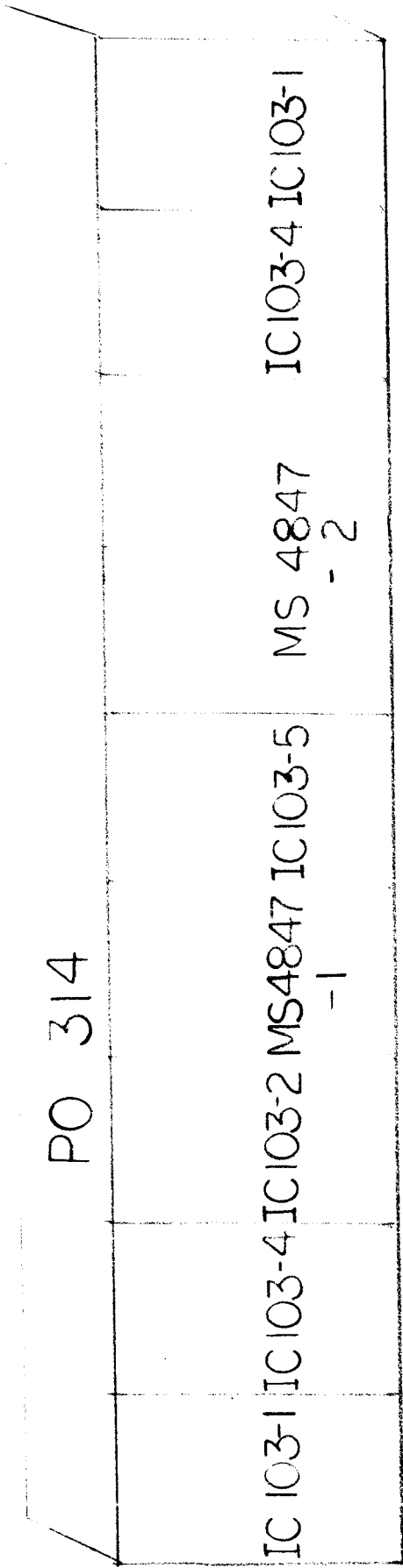

FRONT VIEW

REQ. ITEM	PART NO.	EATON	DESCRIPTION	SYMBOL
			THE TECHNICAL MATERIEL CORP. MAMARONECK. NEW YORK	
	STOCK SIZE		CHART, READOUT INSTALL	
	MATERIAL		RTIH-1	
	TYPE & TEMPER		J. MUNFORD 12-30-65	
	HEAT TREAT. SPEC.		29.4	
	FINISH & SPEC. NO.		DRAWN	
			CHECKED	
			FINAL APPROVAL	
			CH 537	

REV:

COMPILED: 28 5/5/66

CHECKED: 28

APPD: 28 ~~MM~~

SHEET 1 OF 2

TITLE: CHART, UNIT BREAKDOWN - RTIH-1

CH 536

		<u>QTY</u>
RTIH-1	REMOTE TUNING INDICATOR	1
. A5393	RTIH-1 FNL ASSY	1
.. A4375 (NPL)	MEM GT CKT	5
.. AX618 (NPL)	RTIH-1 SUBASSY	1
. LP106	LOOSE IT. PKG	1

REQ. PER UNIT	MODEL	USED ON	SYMBOL
	RTIH-1	ASS'Y. NO. #	CH 537
		DATE	
		12-30-65	

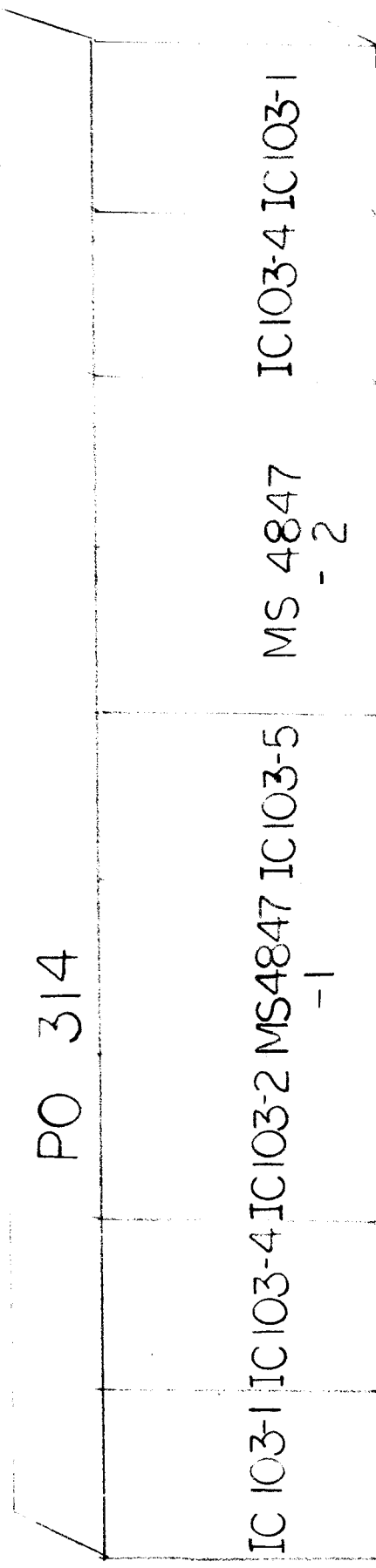

FRONT VIEW

REQ. ITEM	PART NO.	EATON	DESCRIPTION	SYMBOL
			THE TECHNICAL MATERIEL CORP. MAMARONECK. NEW YORK	
	STOCK SIZE		CHART, READOUT INSTALL	
	MATERIAL		RTIH-1	
	TYPE & TEMPER	J. MUNFORD 12-30-65	29.4	
	HEAT TREAT. SPEC.		CHECKED	FINAL APPROVAL
	FINISH & SPEC. NO.			CH 537
			ELEC. DES. APP.	MECH. DES. APP.
			MLX	

SYM DESCRIPTION DATE CH. NO. DRAFTS CHECKER ENG. APP.
 ORIGINAL RELEASE 1/4/65
 UNLESS OTHERWISE SPECIFIED DIMENSIONS ARE IN INCHES AND INCLUDE CHEMICALLY APPLIED OR PLATED FINISHES
 TOLERANCES FRACTIONS
 .X ± .05 ± 1/64
 .XX ± .01 ANGLES
 .XXX ± .005 ± 0° 30'

REV: 0																					
COMPILED: LG. 4/3/66	CHECKED: LG.	APPD: LG.								SHEET	1	OF	2								
TITLE: CHART, UNIT BREAKDOWN																					

CH 542

			<u>QTY</u>
TOC-7		CASE, OPER/TRANS	1
.	A5433	TOC-7 FNL ASSY	1
..	A5434	CASE ASSY	1
...	A5428	FAN/PLATE ASSY	1
...	A5490	INS, FDTHRU	1
...	AX622	STRIP ASSY, AC	1
.....	CA953-2-120	CBL ASSY, AC	1
....	PX976	CASE/COV	1
..	CA412-73-9.25	LEAD, ELEC	1
..	CA480-3-6	CBL ASSY, RF	2
..	CA480-3-11	CBL ASSY, RF	2
..	CA480-129-13	CBL ASSY, RF	1
..	CA953-1-20.00	CBL ASSY, PWR, AC	1
..	CA1068-1	CBL ASSY, PWR, AC	2
..	CA1204	CBL ASSY, PWR	1
..	CA1205	CBL ASSY, SP	1
..	CA1219	WRG HARN, BRCHD	1

REQ. PER UNIT	MODEL	USED ON
1	LPF-750-3	ASSY. NO. DATE
		LPF-750-3 3-24-66
		CH552

LOW PASS FILTER
LPF-750-3

LFP-750-3, ASSY
A4439

REFERENCE DWGS AND SPECS

LEAD, ELEC
CA1229
4 PER

COIL, RF, FXD
CL389
2 PER

COIL, RF, FXD
CL390

COIL, RF, FXD
CL391
2 PER

REQ. ITEM	PART NO.	DESCRIPTION	SYMBOL
		THE TECHNICAL MATERIEL CORP. MAMARONECK, NEW YORK	
		CHART, UNIT BKDN	
		H. SCHUMCKER 3-24-66	
		DRAWN	
		CHECKED	
		FINAL APPROVAL	
		ELEC. DES. APP.	CH552
		MECH. DES. APP.	

DATE 3/25/66
SCALE
UNLESS OTHERWISE SPECIFIED DIMENSIONS ARE IN INCHES AND INCLUDE CHEMICALLY APPLIED OR PLATED FINISHES
TOLERANCES
DECIMALS
.X ± .05
.XX ± .01
.XXX ± .005
FRACTIONS
± 1/64
ANGLES
± 0° 30'

REV: 0

COMPILED: L.GABEL 7/22

CHECKED: L.G. 7/22/66

APPD: LG

AAA

SHEET 1 OF 2

TITLE: CHART, UNIT BKDN - TSTE-10K

CH553

	QTY
TSTE-10K	1
CHGR-3	1
AX547-2	1
A3747	1
A4169	1
AX556	1
CMRA-1	1
A3822	1
A4215	1
A4216	1
A4217	1
A4218	1
A4219	1
A4220-1	1
A4220-2	1
A4220-3	1
A4220-4	1
HFP-1	1
HFSA-1	1
HFS-1	1
AX383	1
AX384	1
AX385	1
AX386	1
AX387	1
AX388	1
AX389	1
KIT-249	1
LRCD-1	1
AZ103	1
RFTA-1	1
SWCU-1	1
AM126	1
AP126	1
AP131	1
APP-11	2
AR176	1
AX103	1
AX107	1
AX560	1
AX563	1
AX566	1
AX570	1
AX580	1
AF104	1
AF105	1
AX610	1
AX611	1
AX612	1
AX613	1
TECHNIMATIC XMTR	1
RF TRANSLATOR	1
TUNER/GR ASSY	1
TUN.GR ASSY	1
BANDSW GR ASSY	1
CHAS ASSY,MAIN	1
SB EXCITER	1
TEST CARD	1
PWR SUP.MODL	1
SYNTH A MODL	1
LOGIC MODL	1
SYNTH B MODL	1
OUT.AMPL MODL	1
IF AMP,CH A1	1
IF AMP,CH B1	1
IF AMP,CH A2	1
IF AMP,CH B2	1
PWR SUP.	1
CONT-SYNTH	1
CONT-SYNTH	1
FP/FRAME	1
100 CYC SEL DECK	1
1 KC SEL DECK	1
10 KC SEL DECK	1
100 KC SEL DECK	1
1 MC SEL DECK	1
RE GEN DIV	1
AUTO-KIT	1
CONT TERM.	1
AMPL,SERVO	1
RF AMPL	1
SWR CONT UNIT	1
MTR BOX,MAIN	1
PWR SUP.,RFTA	1
PWR SUP.	1
AUX PWR PNL	1
REL PNL,MAIN	1
HVR	1
MTR BOX, AUX	1
CONT PNL,AUX	1
AUX FR ASSY	1
REL PNL	1
AUX ADPT PNL	1
PA DECK	1
LP FIL	1
HARM BP FIL	1
CONT PNL,MAIN	1
MAIN FR SUBASSY	1
ENCL/ACCESS.	1
MAIN FR ASSY	1

REV: 0

COMPILED: 2/26/66

CHECKED: Z8

APPD: Z8

~~MM~~

SHEET 1 OF 2

TITLE: CHART, UNIT BKDN - RTO-1A

CH554

		<u>QTY</u>
RTO-1A	TEST OSC	1
. A5363-2	RTO-1A FNL ASSY	1
.. A5365	PNL ASSY,FR	1
.. A5488	CHAS ASSY	1
... A4364	PC BD ASSY	2
.... TZ143	XFMR,RF	1
... CA1236	WRG HARN,BRCHD	1

REV: ①

COMPILED: JES

CHECKED: JES

APPD: JG 5/3/66

SHEET

1

OF

2

TITLE: CHART, UNIT BREAKDOWN

APP-14

. A5489

.. CA409-209-2.75
 .. CA409-210-10.00
 .. CA409-211-2.75
 .. CA409-212-8.00
 .. CA409-213-4.50
 .. CA409-214-2.50
 .. CA409-215-1.75

AUX PWR PNL

APP-14 FNL ASSY

LEAD,ELEC

LEAD,ELEC

LEAD,ELEC

LEAD,ELEC

LEAD,ELEC

LEAD,ELEC

LEAD,ELEC

QTY

1

1

1

1

1

1

1

1

2

CH 556

REV:																				
COMPILED: P. BUER	CHECKED: J. SABATINO	APPD:	SHEET 1 OF 1																	
TITLE: CHART UNIT BKDN																				

CFA-2			1
. A-5520	FREQ SHIFT CONV		1
.. A-4343	CFA-2 FNL ASSY		1
.. A-4345	LOW V SUP. MODL		1
.. A-4347	DET AMPL MODL		2
.. A-4348	LINE SUP MODL		1
.. A-4353	RISER BD		1
... A-4458	OUTPUT MODL		1
.. A-4355	TT283 ASSY		1
.. A-4357	DRIVER MODL		1
.. A-4476	INPUT MODL		2
... A-4457	DISCR MODL		2
.. A-5521	CL397 MODL		1X2
... A-5522	CFA-2 SUBASSY		1
... A-5523	PNL ASSY,FR		1
... A-5524	CHAS ASSY,CONN		1
... A-5525	BRKT ASSY,COMP		1
... A-5526	CHAS ASSY,XFMR		1
... A-5527	PL ASSY,REAR		1
... A-5528	PL ASSY,L SD		1
... CA1257	PL ASSY,R SD		1
. LP111	WRG HARN,BRCHD		1
.. CA1068-1	LOOSE IT. PKG		1
	CBL ASSY,PWR		1

REV:

--	--	--	--	--	--	--	--	--	--	--	--	--	--	--	--	--	--	--	--

 COMPILED: *[Signature]* CHECKED: APPD: *[Signature]* 3/16/67 SHEET 1 OF 1

TITLE: CHART, UNIT BREAKDOWN - AF107

CH557

			<u>QTY</u>
AF107		LOW PASS FILTER	1
.	A-5584	FNL ASSY, AF107	1
..	A-5583	CHAS ASSY	1
...	A-5582	COUP ASSY, DIR	1
...	CL404-1	COIL, RF	2
...	CL404-2	COIL, RF	2

REV: Q

COMPILED: HS

CHECKED: ZS 6/9/66

APPD: ZS ZJ

SHEET 1 OF 2

TITLE: CHART, UNIT BREAKDOWN - RAK-12H

CH559

		<u>QTY</u>
RAK-12H	CAB.,ELEC EQUIP	1
. A5508	RAK-12H FNL ASSY	1
.. A2079-9	FAN ASSY	1
... CA409-32-2.00	LEAD,ELEC	2
... CA550	WRG HARN,BRCHD	1
... CA575-6	CBL ASSY,PWR,AC	1
.. AX630	STRIP ASSY,AC	1
.. CA435-4	CBL ASSY,PWR,AC	1
.. CA555-4	CBL ASSY,PWR,AC	1
.. CA581-2	CBL ASSY,PWR,AC	2
.. CA605-4	CBL ASSY,PWR,AC	3
.. CA676-9-82.00	CBL ASSY,SP	1
.. CA950-3-36.00	CBL ASSY,PWR,AC	1
.. CA950-4-54.00	CBL ASSY,PWR,AC	1
.. CA1178-1	CBL ASSY,SP	1
.. CA1237	WRG HARN,BRCHD	1
.. MS4939	CAB.,EL EQ-MODIF	1
... MS2509-2	CAB.,EL EQ-BASIC	1
.. MS2513	DOOR,REAR	1

CH 574

REV:

COMPILED: Y. AURISY

CHECKED: *JA* 2-7-67

APPD: *JE*

SHEET OF

TITLE: CHART, UNIT BREAKDOWN - LRCF-1

LRCF-1

. BMA145

.. A-4535

.. BMA146

.. CA1292

TERMINAL PANEL

LRCF-1 FNL ASSY

PC BD ASSY

PNL ASSY,FR

WRG HARN,BRCHD

QTY

1

1

1

1

1